

Anatomy of a **Barn**

Your Guide to Pacific Northwest Types, Styles & Character Defining Features



Michael Houser,
*Washington State
Architectural Historian*



October - 2017

Barn Elements



Barn Elements

Wing **vs.** Ell **vs.** Lean-to

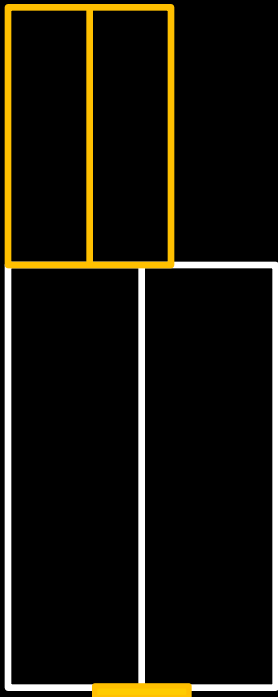

Wing

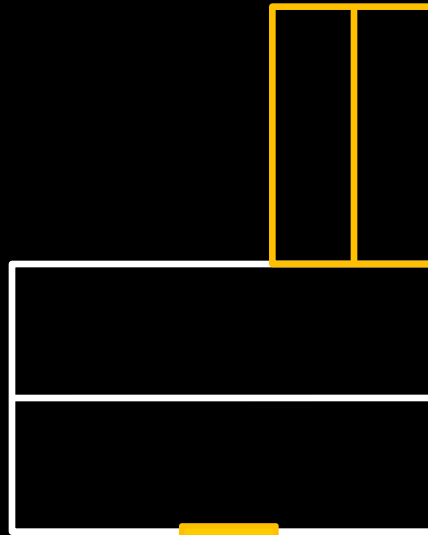

Ell



Lean-to

Barn View in Plan

Barn

Forms and Types

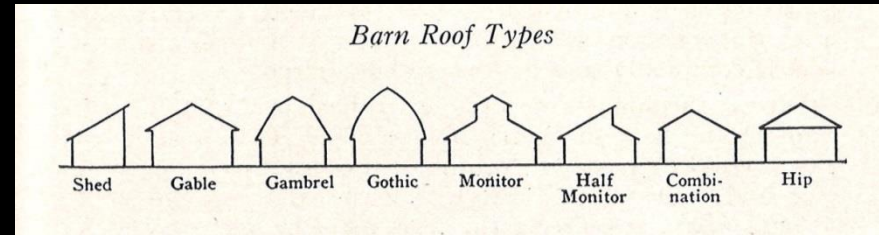

Barn classification can be based on:

- Use/Purpose,
- Plan and shape,
- Framing system,
- Roof form ← DAHP method

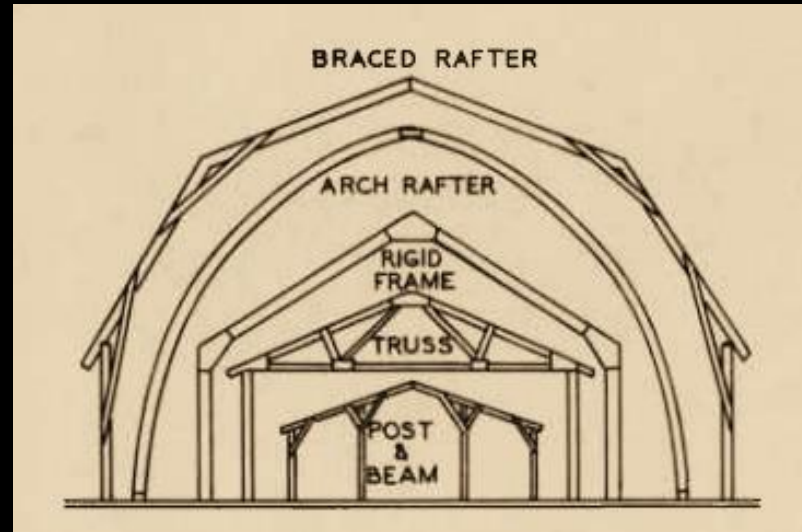

HALLOWEEN MASQUERADE DANCE
TOMLINSON'S BARN
 3½ Miles West of Plaza on Bonnie Lake-Plaza Road

Souvenirs
Prize Waltz
Three Special Prizes



Special Feature
DOT & DASH
High Class Entertainers

Best Character Costume—Gentleman
 Best Character Costume—Lady
 Most Comical Costume

CHET GRIFFITH'S NIGHT HAWK ENTERTAINERS

Lunch Room In Connection

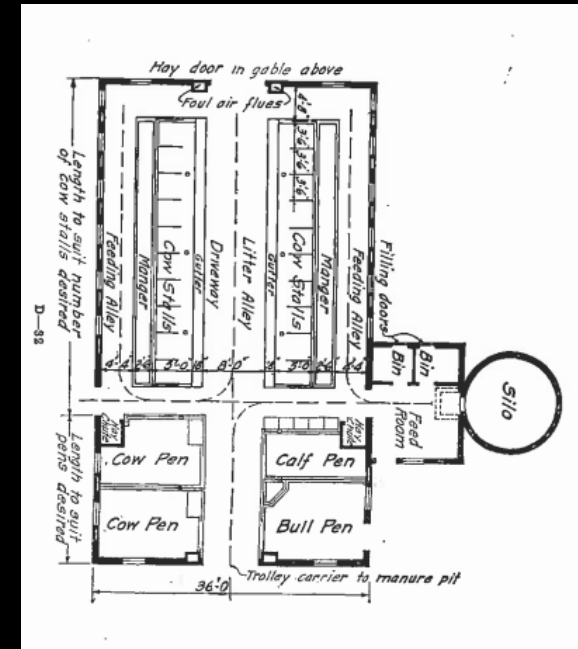

Barn - Forms & Types

Gable (sometimes referred to as an English / Yankee barn)



Shed, OR



Boyd, OR



Champoeg State Park, OR



Hillsboro, OR



Kitsap County, WA

Barn - Forms & Types

Gable (sometimes referred to as an English barn)



Adams County, WA



Adams, OR



Peirce County, WA



Lincoln County, WA



Skagit County, WA



Dayville, OR

Barn - Forms & Types

Salt Box (integrated lean-to)



Dayton, WA



Spokane County, WA



Wallowa Valley, OR



Brownsville, OR



Pierce County, WA

Barn - Forms & Types

Salt Box (integrated lean-to)



Benton County, OR



Finley National Wildlife
Refuge, Benton County, OR



Philomath, OR



Waitsburg, WA



Poulsbo, WA

Barn - Forms & Types

Dutch Barn (roof projecting down to 1st floor)



Stevens County, WA



Dufur, OR



Benton County, OR



Snohomish County, WA



LaPine, OR

Barn - Forms & Types

Dutch Barn (roof projecting down to 1st floor)



Labanon, OR



Colfax, WA



Skagit County, WA



Victor Point, OR

Barn - Forms & Types

Broken Gable / Gable with High Lean-tos



Klamath Falls, OR



Walla Walla, WA



Mount Angel, OR



San Juan County, WA



Hayward, OR

Barn - Forms & Types

Broken Gable / Gable with High Lean-tos



Diamond, OR



Deschutes County, OR



Baker, OR



Walla Walla County, WA

Barn - Forms & Types

Gable-on-Hip



Drake Crossing, OR



Snohomish, WA



Coupeville, WA



Burnt Wood, OR

Barn - Forms & Types

Gable-on-Hip



Walla Walla County, WA



Weston, OR



Dufur, OR



Molalla, OR



San Juan County, WA

Barn - Forms & Types

English Gambrel



Thurston County, WA



Ellensburg, WA



Enterprise, OR



Donald, OR



Lynden, WA

Barn - Forms & Types

English Gambrel



Tangent, OR



Columbia County, WA



Near
Crater
Lake, OR



Lincoln County, WA

Barn - Forms & Types

Dutch Gambrel (note flare at eave line)



Fairfield, WA



Elgin, OR



Grays Harbor, WA



Scappose, OR



Willamette Valley, OR



Salem, OR

Barn - Forms & Types

Dutch Gambrel (note flare at eave line)



Woodburn, OR



Pendleton, OR



Pend Oreille County, WA



Troutdale, OR



Island County, WA

Barn - Forms & Types

Gambrel w/Lean - To



Pierce County, WA



Mount Vernon, WA



Elgin, OR



Yakima County, WA

Deer Park, WA

Barn - Forms & Types

Gambrel w/Lean - To



Eugene, OR



Scholls, OR



Snohomish County, WA



Sheridan, OR

Barn - Forms & Types

Hip



Coupeville, WA



Condon, OR



Moxee, WA



Vancouver, WA

Barn - Forms & Types

Gothic (pointed arch roof truss)



Keizer, OR



Lacey, WA



Vancouver, WA



Willamette Valley, OR



Wilbur, WA

Barn - Forms & Types

Gothic (pointed arch roof truss)



Stayton, OR



Colfax, WA



Uniontown, WA



Weston, OR

Barn - Forms & Types

Bow / Rainbow Truss

(note completely arched trusses)



Grays Harbor County, WA



Pullman, WA



Ridgefield, WA

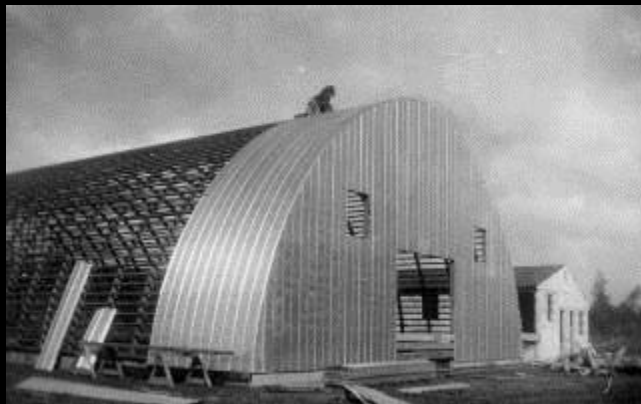

Satsop, WA



Sedro Wooley, WA

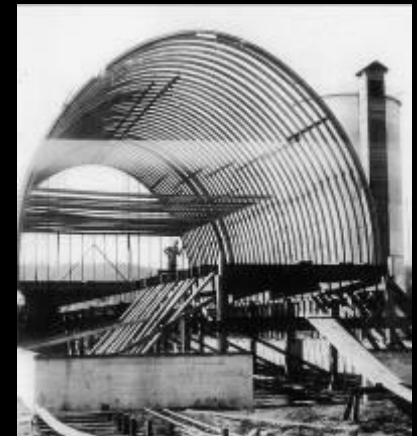

Barn - Forms & Types

Western Barn/ Monitor Barn / Basilican



Joseph, OR

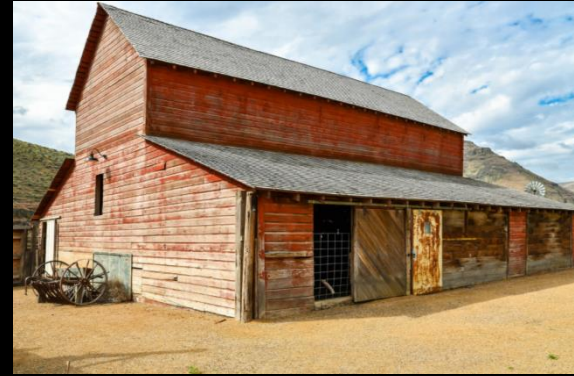

Wasco, OR



Pouso, WA



Yakima County, WA



Skagit County, WA

Barn - Forms & Types

Western Barn/ Monitor Barn / Basilican



Stanwood, WA



Joseph, OR



Linn County, OR



Thurston County, WA

Barn - Forms & Types

Conical / Round / Centric Barns



Klickitat County, WA



Medical Lake, WA



Lostine, OR



Joseph, OR



Diamond, OR



St. Johns, WA

Barn - Forms & Types

Centric / Round / Conical Barns



Lakeview, OR



Hillsboro, OR



Pullman, WA



Grandview, WA



Blachly, OR



Lookingglass, OR

Barn Paint

HOMEGUARD SUPER QUALITY BARN PAINT

This brilliant red, high gloss, top grade paint will protect your property for years. It is economical because it wears so long. Barn paint must provide maximum protection at minimum cost. Made from the finest ingredients available . . . assures great covering power and extreme durability. Each of its fine, balanced characteristics prove this to be, "a barn paint of real quality."

HOME guard
SUPER QUALITY

PAINT FINISHES FOR EVERY SURFACE



- INTERIOR GLOSS ENAMEL
- SEMI-GLOSS FINISH
- HOUSEHOLD ENAMEL
- DURA-TONE
- COLOR VARNISH
- AUTO ENAMEL
- EXTERIOR PAINT
- EXTERIOR TRIM
- PORCH & FLOOR ENAMEL
- SHINGLE STAIN
- IMPLEMENT ENAMEL
- BARN PAINT

GAMBLE STORES
MINNEAPOLIS

WESTERN STORES
LOS ANGELES

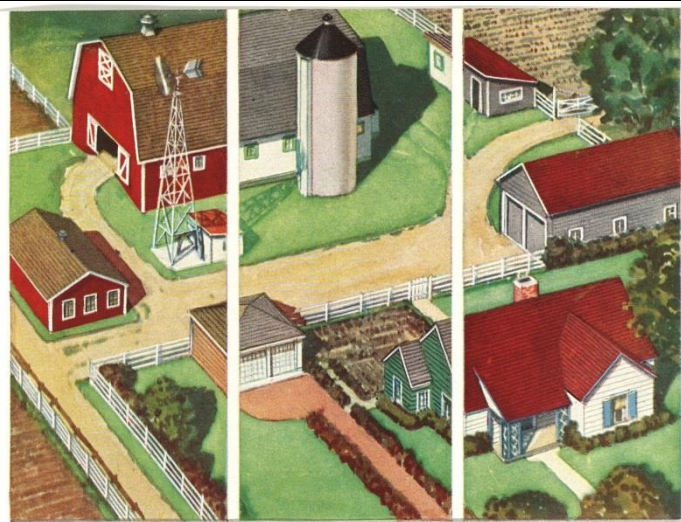

LIFE IS COLORFUL DOWN ON THE FARM

Red, for the barn and sheds, stands out in colorful contrast to the surrounding country. Natural shingle roof and white trim. Garage, Colonial Yellow. Fence, White. Windmill, Aluminum paint.

Shades of green with white and gray make up this attractive scene! Verd Green house with white trim. White barn has Silver Gray shingles and Dark Green trim. Garage and fence, White.

For your White house consider Light Blue trim, a Venetian Red roof, for an attractive color scheme. French Gray sheds have Venetian Red roofs. Fence is White. Colors blend together nicely!



Barn Paint

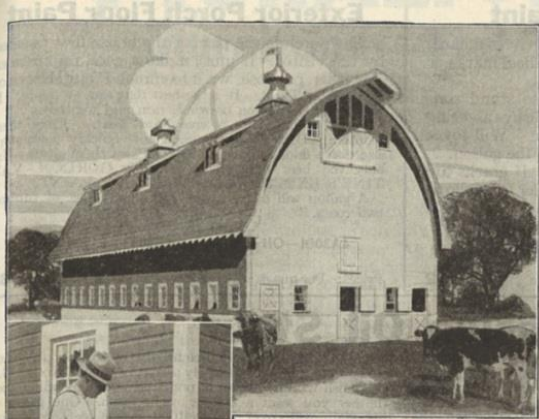

Barn Paint

Use Gordon-Van Tine "Quality" barn paint and be assured of success with your painting.

Farmers judge each other by their barns. Keep your barn well painted. Everyone sees it and it's the one best evidence of thrift and "getting on."

Our "Quality" brand barn paint is good and we know it. We don't sell anything but good paint. It is equally good for shingles or metal roofs, fences, bridges, grain elevators and silos. It will lengthen the life of shingles and metal roofing. It is a wood preservative and will add years to the life of your building.

You may use this paint with perfect confidence, knowing that we will stand back of every can or barrel. Only the best ingredients are used. It is ground to an unusual fineness and thoroughly mixed and remixed by the most up-to-date machinery.

One gallon of Quality barn paint can be depended upon to cover about 250 square feet of surface, two full coats. Measure for it by the "square foot" method. You will never regret having given it a trial. Colors (See Page 65).

4A2001—Light Gray. 4A2002—Venetian Red. 4A2003—Mineral Red.

PRICES PER GALLON

25 and 50 Gallon Barrels	Reds \$1.33 Gray 1.60	5 Gallon Kits	Reds \$1.42 Gray 1.70	1 Gallon Cans	Reds \$1.55 Gray 1.80
-----------------------------	--------------------------	------------------	--------------------------	------------------	--------------------------

BARN PAINT A most durable and handsome paint for barns and outbuildings. Prices of lead and zinc make gray cost more than reds. **See index on opposite page**



4A2001 Light Gray



4A2002 Venetian Red



4A2003 Mineral Red



Gordon-Van Tine
Co. Catalogue –
c.1924

Barn Plans

- Farmer
- Itinerant Builder
- Architect
- Plan Service
- Extension Office
- Lumber Yard / Plan Service
- Pre Cut



BLUE PRINTS
AND
COMPLETE SPECIFICATIONS
SHOULD BE USED WHEN BUILDING

Because you will know in advance how the building will look.
Because you will know in advance what the building will cost.
Because you will save money by saving the contractor's time.
Because we can furnish these plans and specifications at such a low price that you cannot afford to do without them.

Come to Our Office and Get Our Special Blue-Print Proposition

Barn Plans Ready Cut

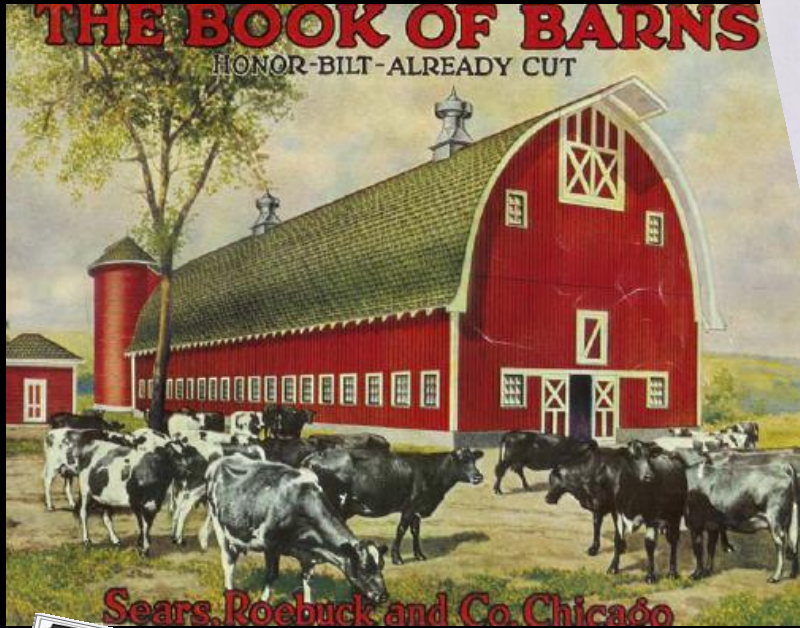

Sears & Roebuck - 1919



Fenner Barn No. 422

BARN No. 422, the standard size of which is 36x60, is a good sized barn for general use. The strong, gambrel roof adds many cubic feet of space to the already large loft, and makes an excellent outside appearance. The driveway goes clear through the barn, in the center. To the left of this driveway are stalls and accommodations for live stock, while the space to the right may be used for storing wagons and implements, or may be used for grain and feed. The barn in the picture is equipped with a silo, which, of course, we do not furnish.

It is our policy to show in this catalog only those barns which are of accepted and standard design that they are recognized as the leaders of where. Should the interior arrangement need changing to meet your requirements, we can change it, not only in this, but in any of our barns. Or, wish a barn of any special design, it will pay you to get our prices, and to your own station, all cut to fit and ready to put together easily and

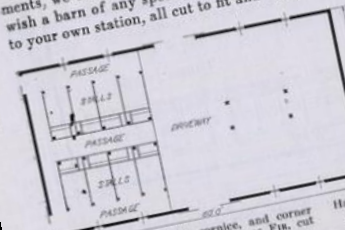

SPECIFICATION
Size, 36'x60'.
Celling heights, first tier, 14'.
Interior walls, 14'.
Center girders and sills, 6x8.
Posts, 6x6 and 4x4.
First floor joists, under stalls, 2x8, 16" O. C.
Loft joists, 2x10, 16" O. C.
Studding, 2x6, 24" O. C.
Rafters, 2x4, 24" O. C.
Sheathing for roof.
Roof, Extra * A * red cedar shingles.
Floors, stalls, 2x12 plank, and loft, 1x4 flooring.
Hardware, nails, hinges, locks, and corner boards are of high grade DOUGLAS FIR, cut in our mills.



Fenner Barn No. 421

BARN No. 421 is designed for a small farm or for a person living in a small town who wishes to keep a number of horses or cattle. It is a standard design that has met with general approval and really allows a great many square feet of highly usable room for the price. Such a good sturdy barn as this greatly enhances the value as well as the looks of any place.



There are five stalls with a light, well ventilated passage-way in the rear. Each stall is provided with feed boxes, and three large feed bins are provided in a convenient location. Note also the tool room. The left door is left in large, and is in no proportion to the size of the barn, being calculated to hold enough feed to supply animals for a year. The mission is to ventilate and carry off all odors, which it does very effectively.



SPECIFICATIONS
Size, 28'x36'.
Center girders and sills, 6x8.
Posts, 6x6 and 4x4.
First floor joists under stalls, 2x8, 16" O. C.
Studding, 2x4, 16" O. C.
Rafters, 2x4, 24" O. C.
Sheathing for roof.
Roof, Extra * A * red cedar shingles.
Floors, stalls, 2x12 plank, and loft, 1x4 flooring.
Hardware, nails, hinges, locks, and corner boards are of high grade DOUGLAS FIR, cut in our mills.



FENNER PLAN BOOK
OF FACTORY CUT HOMES
PORTLAND, OREGON

Fenner Manufacturing Co.,
Portland, OR - 1921



Gordon Van Tine- 1915

Barn Plans Extension Service

STATE AGRICULTURAL EXPERIMENT STATION
Pullman, Washington, September 1, 1915

POPULAR BULLETIN No. 95

The Dairy Barn and Milk House, How to Construct Them

By
R. E. HUNDERTMARK
Instructor in Dairy Production, State College
of Washington
and
A. B. NYSTROM
Dairy Husbandman of the Experiment Station

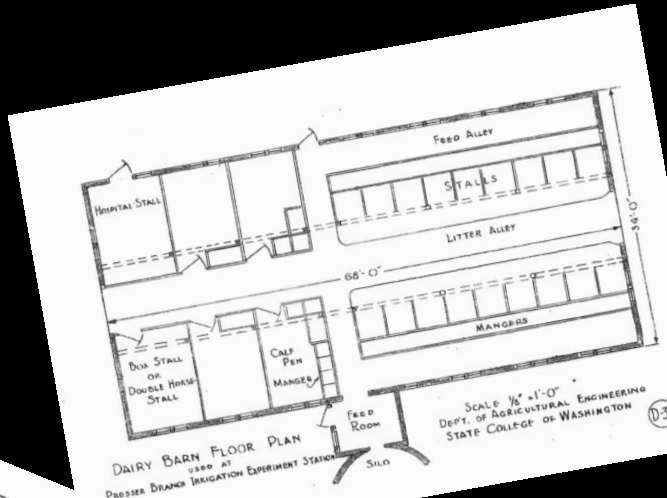

WSU Extension - 1934

Planning Farm Buildings

Selecting the Type of Farm Building
Consider the following to help decide the type of building that will best serve your needs. Consider floor space, layout, and height. Consider the cost of the building and the cost of the land on which it will be built. Consider the type of animals to be housed and the type of work to be done in the building.

Construction
Consider the following to help decide the type of building that will best serve your needs. Consider floor space, layout, and height. Consider the cost of the building and the cost of the land on which it will be built. Consider the type of animals to be housed and the type of work to be done in the building.

Planning Farm Buildings
A farm building purchase is a major project that is not often repeated. Engineer changes in construction methods, building designs, and layout arrangements, plus the availability of new building materials make it advisable to review current literature prior to selecting a specific structure. This service will help the buyer obtain a more factual and practical basis for building. Sources of plans and additional planning information are listed. These are available (costs range from \$1.00 to \$10.00 per item) from the Western Regional Agricultural Engineering Service (WRAES), Oregon State University, Corvallis, OR 97331 (phone 754-4021).

Types of Farm Buildings
When planning a specific building, consider the various types of construction (shown below). The various types of farm buildings have different names and if proper communication is to refer to these with proper terminology.

BRACED RAFTER
GABLE RAFTER

Extension Circular 2026
EXTENSION SERVICE

extension bulletin no. 483
STATE LIBRARY
OCT 7 1950
OLYMPIA, WASH.

PLANNING YOUR DAIRY BUILDINGS

october - 1953

farm structures series

WASHINGTON STATE LIBRARY
STATE DEPOSITORY COPY

RECEIVED
NOV 1958
WA STATE LIBRARY

extension service - institute of agricultural sciences
state college of washington - pullman, washington

WSU Extension - 1953

WSU Extension - 1915

OSU Extension - 1981

Smith-Lever Act of 1914

Barn Plans Lumber Yard / Plan Service

1953



Professionally Planned Farm Buildings

WITH COMPLETE BLUEPRINTS AND MATERIAL LISTS

Builders who are active in farm construction report that they are receiving valuable assistance from the Weyerhaeuser 4-Square Farm Building Service. It enables them to erect professionally planned farm buildings that give greater satisfaction to farmers, while the blueprints and accurate material lists make for easier, faster construction.

Weyerhaeuser developed this Service with the cooperation of experts in many fields of agriculture... animal husbandry specialists, crop men, farm structure engineers, home economists and experienced farmers and farm managers.

Out of their knowledge and experience have come two basic requirements which good buildings must meet to be classified as truly modern and efficient structures. First, they must meet functional or use requirements in order to serve an ideal farm tool. Second, they must meet standards of durable, economical construction.

The 204 designs in the Weyerhaeuser 4-Square Farm Building Service meet the exacting requirements for buildings of maximum use value, minimal cost and enduring service. They meet the needs of modern farming... which is under increasingly greater pressure to reduce production costs, increase yield and improve quality.

The 4-Square Farm Building Service, with its access of modern designs, is ready for your use in serving farm prospects. We will gladly send, on your request, the 64 page book titled, "Modern Homes and Buildings For The Farm" which illustrates and describes many of the Homes and Service Buildings. We will also send you the name of the Weyerhaeuser 4-Square Lumber Dealer in your community who has available complete blueprints and material lists for all the buildings in the Service. Write our Builders' Division.

Weyerhaeuser Sales Company
ST. PAUL 1, MINNESOTA
MARCH, 1953 - PRACTICAL BUILDING, CHICAGO 2 113



Mrs. Adolph... ASTORIA, OREGON.

ASTORIA LUMBER CO.
MANUFACTURERS OF
RED CEDAR AND HEMLOCK LUMBER BUILDINGS AND FURNITURE
1001 1/2 BROAD STREET

TERMS CASH

Item	Specs	Qty	Description	Quantity	Price	Total
1	2 X 10	80	2x10 / 12' / 12'	80.00	8.00	880.00
2	2 X 10	20	2x10 / 12' / 12'	20.00	2.00	200.00
3	2 X 10	18	2x10 / 12' / 12'	18.00	1.80	180.00
4	2 X 10	15	2x10 / 12' / 12'	15.00	1.50	150.00
5	2 X 10	12	2x10 / 12' / 12'	12.00	1.20	120.00
6	2 X 10	10	2x10 / 12' / 12'	10.00	1.00	100.00
7	2 X 10	8	2x10 / 12' / 12'	8.00	.80	80.00
8	2 X 10	6	2x10 / 12' / 12'	6.00	.60	60.00
9	2 X 10	4	2x10 / 12' / 12'	4.00	.40	40.00
10	2 X 10	2	2x10 / 12' / 12'	2.00	.20	20.00
11	2 X 10	1	2x10 / 12' / 12'	1.00	.10	10.00
12	2 X 10	1	2x10 / 12' / 12'	1.00	.10	10.00
13	2 X 10	1	2x10 / 12' / 12'	1.00	.10	10.00
14	2 X 10	1	2x10 / 12' / 12'	1.00	.10	10.00
15	2 X 10	1	2x10 / 12' / 12'	1.00	.10	10.00
16	2 X 10	1	2x10 / 12' / 12'	1.00	.10	10.00
17	2 X 10	1	2x10 / 12' / 12'	1.00	.10	10.00
18	2 X 10	1	2x10 / 12' / 12'	1.00	.10	10.00
19	2 X 10	1	2x10 / 12' / 12'	1.00	.10	10.00
20	2 X 10	1	2x10 / 12' / 12'	1.00	.10	10.00
21	2 X 10	1	2x10 / 12' / 12'	1.00	.10	10.00
22	2 X 10	1	2x10 / 12' / 12'	1.00	.10	10.00
23	2 X 10	1	2x10 / 12' / 12'	1.00	.10	10.00
24	2 X 10	1	2x10 / 12' / 12'	1.00	.10	10.00
25	2 X 10	1	2x10 / 12' / 12'	1.00	.10	10.00
26	2 X 10	1	2x10 / 12' / 12'	1.00	.10	10.00
27	2 X 10	1	2x10 / 12' / 12'	1.00	.10	10.00
28	2 X 10	1	2x10 / 12' / 12'	1.00	.10	10.00
29	2 X 10	1	2x10 / 12' / 12'	1.00	.10	10.00
30	2 X 10	1	2x10 / 12' / 12'	1.00	.10	10.00
31	2 X 10	1	2x10 / 12' / 12'	1.00	.10	10.00
32	2 X 10	1	2x10 / 12' / 12'	1.00	.10	10.00
33	2 X 10	1	2x10 / 12' / 12'	1.00	.10	10.00
34	2 X 10	1	2x10 / 12' / 12'	1.00	.10	10.00
35	2 X 10	1	2x10 / 12' / 12'	1.00	.10	10.00
36	2 X 10	1	2x10 / 12' / 12'	1.00	.10	10.00
37	2 X 10	1	2x10 / 12' / 12'	1.00	.10	10.00
38	2 X 10	1	2x10 / 12' / 12'	1.00	.10	10.00
39	2 X 10	1	2x10 / 12' / 12'	1.00	.10	10.00
40	2 X 10	1	2x10 / 12' / 12'	1.00	.10	10.00
41	2 X 10	1	2x10 / 12' / 12'	1.00	.10	10.00
42	2 X 10	1	2x10 / 12' / 12'	1.00	.10	10.00
43	2 X 10	1	2x10 / 12' / 12'	1.00	.10	10.00
44	2 X 10	1	2x10 / 12' / 12'	1.00	.10	10.00
45	2 X 10	1	2x10 / 12' / 12'	1.00	.10	10.00
46	2 X 10	1	2x10 / 12' / 12'	1.00	.10	10.00
47	2 X 10	1	2x10 / 12' / 12'	1.00	.10	10.00
48	2 X 10	1	2x10 / 12' / 12'	1.00	.10	10.00
49	2 X 10	1	2x10 / 12' / 12'	1.00	.10	10.00
50	2 X 10	1	2x10 / 12' / 12'	1.00	.10	10.00

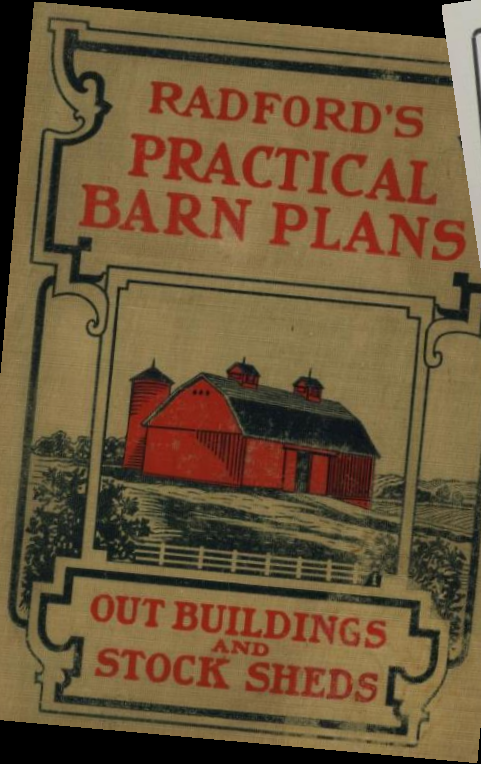

It's Plan-Time Now
For Farm Buildings

Self Supporting Gambrel Roof Barn
and Tum-A-Lum Wood-Hoop Silo

Daylight Chicken Shed

Model Wheat Ranch Machine Shed
With Space for Combine

Open or Closed Front Machine Shed

Granary and Farm Storage House

Sunlight Hog Shed

"Materially Yours"
Whitehouse-Crawford Co.
WALLA WALLA
TUM-A-LUM LUMBER CO.
YARDS IN WASHINGTON AND OREGON
PLANS and MATERIALS for HOMES and FARM BUILDINGS

Barn Plans
and Outbuildings

NEW AND REVISED EDITION

375 ILLUSTRATIONS

NEW YORK: ORANGE JUDD COMPANY
12 West 12th Street

1881

PRACTICAL
IDEAS
FOR THE
HOME & FARM

WITH
Weatherply
(THE ALL-WEATHER PLYWOOD)

GRID-PLY FLUSH DO
RED CEDAR SHING
PACIFIC COAST LUMBER

1952

Radford's Practical
Barns Plans – 1907

1881

Jamesway Co.

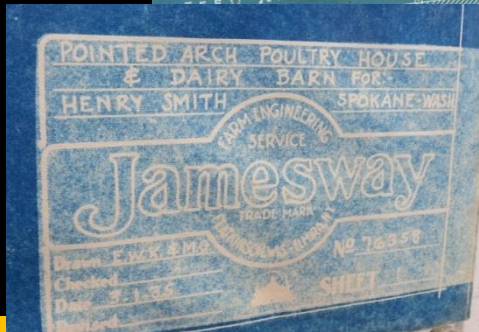
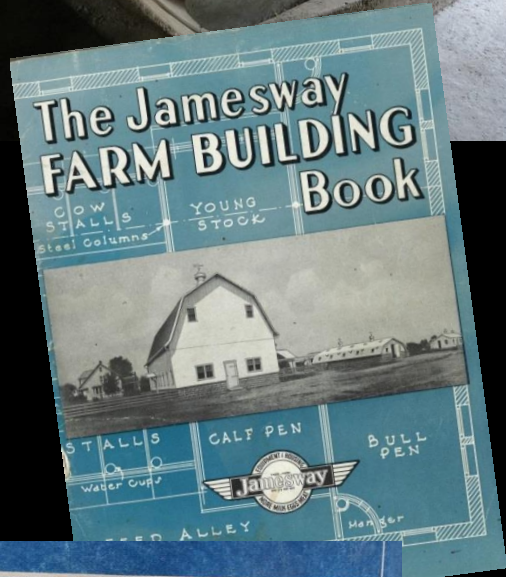
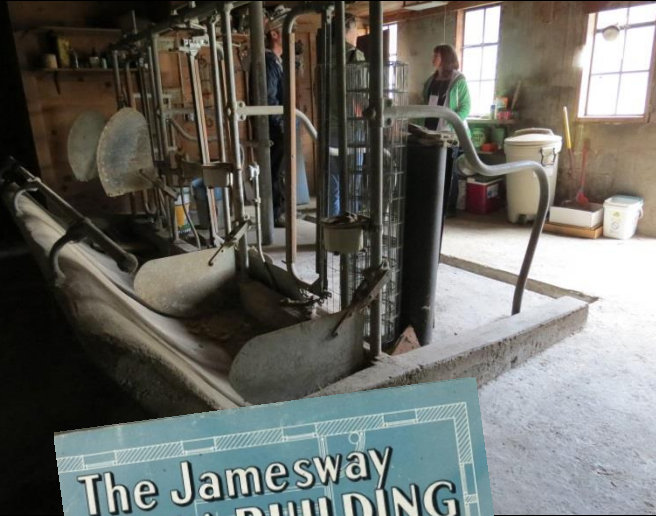

Barn Roofing

- Wood Shake / Shingle
- Standing Seam
- Corrugated Metal
- Asphalt



Barn

Roofing – Wood Shingle / Shake

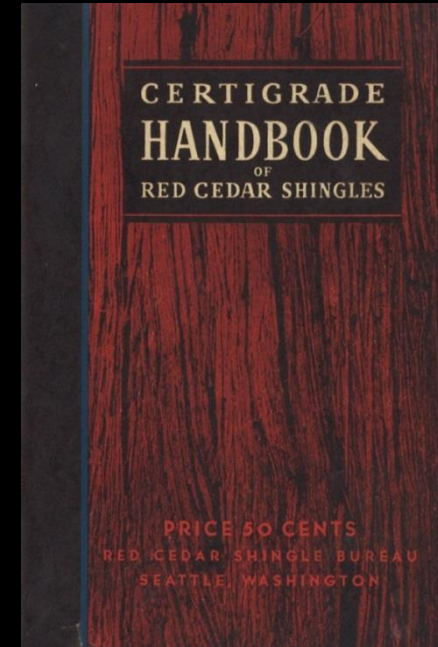

Barn Roofing - Standing Seam

EXTRA HEAVY Two and Three-V Crimp Steel Roofing—U. S. STANDARD WEIGHTS

V Crimp Roofing is in Many Respects the Best of all the various styles of metal roofing. It may be laid over shingles, slates or can be nailed direct to the rafters, which should be spaced 24 inches apart, center to center, and must be covered on one end by a 12 inch or more flat bar. The ridge of the sheeting should be applied 1/2 inch or more flat on the top edge of the sheeting instead of lap joints, as is well positively prevent the rain, snow or wind from blowing in under the sheet.

It is Easily Laid and has many other advantages. It is especially adapted for factories, barns, sheds or temporary buildings, and, as it requires no soldering or lapping or hammering of seams or joints, anyone who has ordinary mechanical ability can put it on. It has a real appearance and is in the most economical and the latest priced style or kind of steel roofing made.

We Illustrate at the Left a sheet of Two-V Crimp Steel Roofing which has a covering width of 24 inches after lapping one strip over the other. This roofing comes in different lengths ranging from 10 to 10 feet, inclusive. In laying V Crimp Roofing the ends of the sheets should be lapped not less than 3 inches when used on roofs having a fall of not less than 2 inches to the foot. The Two-V Crimp sheet overlaps the other sheet 1/2 inch on the top edge. It is laid on the rafters, center to center, and is fastened directly on the rafters. The wood V strip should be nailed on the top surface of the rafters you should use a 1/2 inch or better, rather than a 3/4 inch or better, nail. The rafters should be well covered with paint under the lap and nailed down to the rafter below the rafters. We illustrate how the sheeting is laid on the V Crimp roof should be lapped and nailed to the rafters.

Two-V Crimp Roofing is Shipped Direct From the Blast Mills in EASTERN OHIO.

State Number Sheets in All Orders.

Catalog No.	Feet	10	12	14	16	18	20	22	24	26	28	30
48P3077	24	1.37	1.41	1.45	1.48	1.51	1.54	1.57	1.60	1.63	1.66	1.69
48P3078	30	.92	1.10	1.29	1.48	1.66	1.84	2.02	2.20	2.38	2.56	2.74
48P3079	36	1.32	1.59	1.86	2.12	2.38	2.64	2.90	3.16	3.42	3.68	3.94

Made in HEAVY GAUGE (U. S. Standard 28-Gauge Steel) and EXTRA HEAVY GAUGE (U. S. Standard 26-Gauge Steel).



GOOD ADVICE—Use our extra heavy gauge 26-gauge steel. It is 20 per cent thicker and heavier than the 28-gauge steel. Costs only a trifle more and lasts twice as long. If your building is exposed to salt air we recommend the use of galvanized steel.

We Illustrate at the Right a sheet of Three-V Crimp Steel Roofing which has a covering width of 24 inches from center to center of the outside crimpings. The outside crimpings add strength to the sheet as it follows the top and prevents the sheet from raftering. Three-V Crimp Roofing can be laid directly on the rafters by placing them 24 inches from center to center, but in order to obtain the full value and strength of these sheets, they should be placed over one or two old shingles or on a smooth surface where you can place a wood V strip to support the center crimp.

In laying Three-V Crimp Roofing on a new roof it is only necessary to place shingling strips under the roof, every 2 feet, but laying these strips on the new V strips to properly support and strengthen the center of the sheet.

V Crimp Steel is Used for Siding on barns, sheds and out-buildings.

The sheeting is more securely fastened to the walls of the building than the two-V can be laid on any other wall with ordinary care will last for many years. Two inches end lap is sufficient when using V crimp steel for siding.

Save Money on Your Building by laying the roofing without shingling. See the figure 24 inches from center to center and end of the roof of the rafters. Place rafters between the rafters to support and nail the end of the sheeting on the lower half end center of the roof and lay the sheeting from center to the ridge, allowing the ridge to be covered by the sheeting on the side lap. Use 1/2 inch by 12 inch lumber for the rafters and the ridge. It is best to nail the sheeting on the ridge with about every 3 or 40 inches. At the end lap use nails every 12 or 18 inches.

We Illustrate at the Right a sheet of Three-V Crimp Steel Roofing which has a covering width of 24 inches from center to center of the outside crimpings. The outside crimpings add strength to the sheet as it follows the top and prevents the sheet from raftering. Three-V Crimp Roofing can be laid directly on the rafters by placing them 24 inches from center to center, but in order to obtain the full value and strength of these sheets, they should be placed over one or two old shingles or on a smooth surface where you can place a wood V strip to support the center crimp.

In laying Three-V Crimp Roofing on a new roof it is only necessary to place shingling strips under the roof, every 2 feet, but laying these strips on the new V strips to properly support and strengthen the center of the sheet.

V Crimp Steel is Used for Siding on barns, sheds and out-buildings. The sheeting is more securely fastened to the walls of the building than the two-V can be laid on any other wall with ordinary care will last for many years. Two inches end lap is sufficient when using V crimp steel for siding.

Prices on Steel Roofing and Siding are subject to market changes. If market prices for iron, copper and the benefit of the reduction. We will not attempt to cover the increased cost of an increase in the price of steel. We will not attempt to cover the increased cost of an increase in the price of steel.

PRICES ON THREE-V CRIMP STEEL ROOFING.

Catalog No.	Feet	10	12	14	16	18	20	22	24	26	28	30
48P3086	24	1.18	1.42	1.66	1.90	2.13	2.36	2.59	2.82	3.05	3.28	3.51
48P3087	30	.94	1.13	1.32	1.51	1.70	1.88	2.07	2.25	2.44	2.62	2.80
48P3088	36	1.33	1.60	1.87	2.14	2.40	2.66	2.92	3.18	3.44	3.70	3.96

The above prices are for roofing only and do not include strips or nails. Prices on nails and strips shown on nails and strips shown above.

It requires 50 lined feet of wood V strips and 1 pound barbed roofing nails for each square of the Two-V Crimp Roofing.

SEARS, ROEBUCK AND CO., CHICAGO, ILLINOIS.

Barn

Roofing - Standing Seam

ROLL AND CAP ROOFING

Our Roll and Cap Roofing is laid on all kinds of buildings over both water and land. It is easy to put on, the only metal roofing which is so simple to lay, and of putting up a water-tight roof of any material. It can be laid on any kind of roof, and it is the only roofing which can be laid on a roof which is not level. It is the only roofing which can be laid on a roof which is not level. It is the only roofing which can be laid on a roof which is not level. It is the only roofing which can be laid on a roof which is not level.



Roll and Cap Roofing is laid on all kinds of buildings over both water and land. It is easy to put on, the only metal roofing which is so simple to lay, and of putting up a water-tight roof of any material. It can be laid on any kind of roof, and it is the only roofing which can be laid on a roof which is not level. It is the only roofing which can be laid on a roof which is not level.

Roll and Cap Roofing is laid on all kinds of buildings over both water and land. It is easy to put on, the only metal roofing which is so simple to lay, and of putting up a water-tight roof of any material. It can be laid on any kind of roof, and it is the only roofing which can be laid on a roof which is not level. It is the only roofing which can be laid on a roof which is not level.

Roll and Cap Roofing is laid on all kinds of buildings over both water and land. It is easy to put on, the only metal roofing which is so simple to lay, and of putting up a water-tight roof of any material. It can be laid on any kind of roof, and it is the only roofing which can be laid on a roof which is not level. It is the only roofing which can be laid on a roof which is not level.

PRESSED STANDING SEAM ROOFING

Pressed Standing Seam or Double Cap Roofing is made of a roll of metal which is pressed into a standing seam. It is the only roofing which is so simple to lay, and of putting up a water-tight roof of any material. It can be laid on any kind of roof, and it is the only roofing which can be laid on a roof which is not level. It is the only roofing which can be laid on a roof which is not level.



Pressed Standing Seam or Double Cap Roofing is made of a roll of metal which is pressed into a standing seam. It is the only roofing which is so simple to lay, and of putting up a water-tight roof of any material. It can be laid on any kind of roof, and it is the only roofing which can be laid on a roof which is not level. It is the only roofing which can be laid on a roof which is not level.

Pressed Standing Seam or Double Cap Roofing is made of a roll of metal which is pressed into a standing seam. It is the only roofing which is so simple to lay, and of putting up a water-tight roof of any material. It can be laid on any kind of roof, and it is the only roofing which can be laid on a roof which is not level. It is the only roofing which can be laid on a roof which is not level.

Pressed Standing Seam or Double Cap Roofing is made of a roll of metal which is pressed into a standing seam. It is the only roofing which is so simple to lay, and of putting up a water-tight roof of any material. It can be laid on any kind of roof, and it is the only roofing which can be laid on a roof which is not level. It is the only roofing which can be laid on a roof which is not level.

Sears & Roebuck Roofing Catalogue - 1908

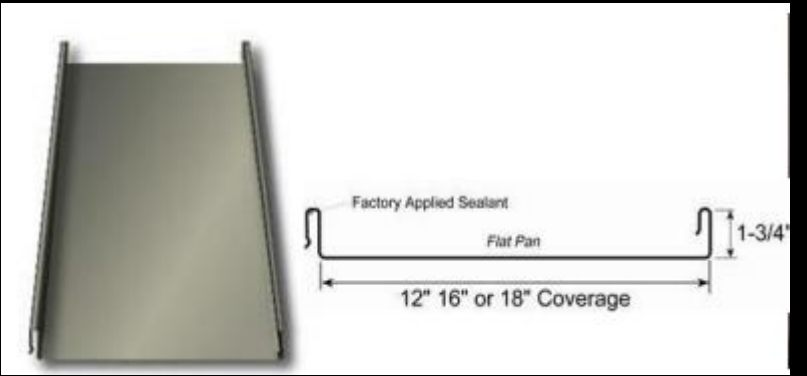

SEARS, ROEBUCK AND CO., CHICAGO, ILLINOIS.

Barn Roofing - Corrugated Metal

EXTRA HEAVY Pressed Corrugated Steel—U. S. STANDARD WEIGHTS

Made in HEAVY GRADE (U. S. Standard 28-Gauge) and EXTRA HEAVY GRADE (U. S. Standard 26-Gauge).

Corrugated Steel is an Excellent Material for roofing, ceiling, siding, awnings, etc. It is especially desirable for grain elevators, mills, barns and fireproof buildings. It requires only a hammer and a pair of tinners' snips to lay corrugated steel either on a roof or side of a building, and for this reason it is especially cheap and easy to lay. It is desirable where a large quantity is used. In putting on corrugated sheet steel the nails should always be driven through the crown or the highest point of the corrugation. Do not hammer the nails down hard enough to batter or flatten the sheet.

Extra Strong on Account of Corrugations. By making sheet steel in this corrugated form it gives the sheet great strength and rigidity. United States Standard 26-Gauge, which is known the country over as standard weight and thickness, and United States Standard 28-Gauge, which we describe as extra heavy and which is 20 per cent thicker and heavier than the standard 28-gauge. We recommend the Extra Heavy Grade, or 26-gauge, in preference to the standard weight (28-gauge), as it costs but a trifle more, costs no more to lay and gives nearly double the wear.

We Furnish Two Thicknesses: 1 1/4-inch corrugated steel roofing comes in sheets 25 feet long and 104 1/2 square feet in area. It is furnished either painted or galvanized. Our painted sheets receive a good coat of dry red mineral paint mixed in oil and dryer which serves as a first coat, and the galvanized sheets are well galvanized on both sides with high grade galvanizing material. We recommend the use of galvanized steel in year buildings is exposed to salt air. Shipped from the steel mills in EASTERN OHIO. We will ship promptly.

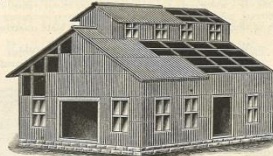

Above illustration shows a factory building partially covered with corrugated sheet steel. It will save that the building the extra length being covered with this material by nailing it direct to the ceiling and rafters. There is no shingling used on either the roof or side of the building. We recommend the use of galvanized steel on all roof covered. The rafter left should be immediately under the steel roofing. It adds to the life of the roof.

When ordering 2 1/2-inch corrugated steel roofing be sure to order 108 1/2 square feet to cover one hundred square feet. This does not include end laps. Allow from 4 to 6 inches for end laps, according to the pitch or slope of your roof. When used as siding, a 2-inch end lap is sufficient.

Be sure to order 104 1/2 square feet of 1 1/4-inch corrugated steel roofing to cover one hundred square feet. This does not include end laps. End laps for corrugated roofing should be from 4 to 6 inches, according to the pitch or slope of your roof. When used as siding a 2-inch end lap is sufficient.

1 1/4-inch Corrugated Sheet Steel comes in sheets 25 feet long and 104 1/2 square feet in area. It is furnished either painted or galvanized. Our painted sheets receive a good heavy coat of dry red mineral paint mixed in oil, which serves as a first coat, while the galvanized sheets are well galvanized. (We recommend the galvanized sheets if your building is exposed to salt air.) 1 1/4-inch corrugated sheets are shipped from the steel mills in EASTERN OHIO.

Above prices do not include paint or nails.

PRICES OF 2 1/2-INCH CORRUGATED STEEL.

Catalog No.	Price, 5-ft. Sheet	Price, 10-ft. Sheet	Price, 15-ft. Sheet	Price, 20-ft. Sheet	Price, 25-ft. Sheet	Price, per 100 sq. ft.	Weight, per sq. ft.
48P3108	\$ 0.84	\$1.01	\$1.18	\$1.35	\$1.52	\$1.68	68 lbs.
28-Gauge, Painted							
48P3106	1.26	1.52	1.77	2.02	2.27	2.52	11.55
28-Gauge, Galvanized							
48P3124	1.00	1.20	1.40	1.60	1.80	2.00	9.20
26-Gauge, Painted							
48P3123	1.43	1.72	2.01	2.30	2.58	2.86	13.12
26-Gauge, Galvanized							

NOTE—Prices on Steel Roofing and Siding are subject to market changes. If the market prices go lower, customers will get the benefit of the reduction; if higher, we will advance only enough to cover the increased cost to us. For roofing that is guaranteed to wear 15 years see colored insert between pages 8 and 15.

PRICES OF 1 1/4-INCH CORRUGATED STEEL.

Catalog No.	Price, 5-ft. Sheet	Price, 10-ft. Sheet	Price, 15-ft. Sheet	Price, 20-ft. Sheet	Price, 25-ft. Sheet	Price, per 100 sq. ft.	Weight, per sq. ft.
48P3107	\$0.82	\$0.99	\$1.16	\$1.32	\$1.48	\$1.64	57.85
28-Gauge, Painted							
48P3108	1.22	1.47	1.72	1.96	2.20	2.44	11.68
28-Gauge, Galvanized							
48P3124	0.98	1.18	1.38	1.58	1.77	1.96	9.33
26-Gauge, Painted							
48P3123	1.38	1.66	1.94	2.21	2.48	2.76	13.24
26-Gauge, Galvanized							

Corrugated Ridge Roll to Fit 2 1/2-inch Corrugated Steel Roofing.
No. 48P3272 28-Gauge, Painted.
Price, per 5-foot length, .50c
No. 48P3270 28-Gauge, Galvanized.
Price, per 5-foot length, .60c
Weight, about 2 1/2 pounds.

TIN SHINGLES OR FLASHINGS
No. 48P3199 Made of a good grade of roofing tin and cut to exact sizes. Useful for repairing old roofs and making a tight joint around chimneys, etc. Painted on one side. Shipped from our CHICAGO store.
Size, 5x7 inches. Price, each, .50c
Per 100 (Shpg. wt., 15 lbs.), 1.50
Size, 7x10 inches. Price, each, .04
Per 100... (Shpg. wt., 30 lbs.), 3.50

VALLEYS—IN ROLLS
No. 48P3198 Made of IC tin plate in a continuous strip, locked and soldered. Put up in rolls. Full lengths are 50 feet, but we can furnish any quantity. Painted on one side. Shipped from our CHICAGO store.

Width, Inches	Price, per 100 ft. Roll	Price, per 50 ft. Roll	Weight, per 100 ft. Roll
14	1.14	58.40	29 lbs.
20	1.56	7.95	41 lbs.
28	2.22	10.78	58 lbs.

GALVANIZED STEEL VALLEY
Put up in rolls. Made in United States standard 28-gauge steel and extra heavy United States standard 26-gauge steel, 14 inches wide. Lock seam and soldered. For valleys and flashings. Shipped from our CHICAGO store.

Catalog No.	Thickness or Gauge	28-Foot Roll	50-Foot Roll
48P3197	28-gauge	\$2.85	70 lbs.
48P3176	26-gauge	\$2.68	34 lbs.

SEARS, ROEBUCK AND CO., CHICAGO, ILLINOIS.

Sears & Roebuck Roofing Catalogue - 1908

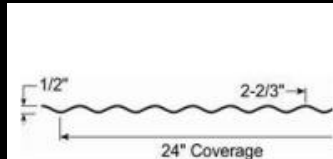

Barn Roofing - Asphalt

Gordon-VanTine Co. - Satisfaction Guaranteed or Money Back PAGE 85

"Jap-a-Top" SLATE SURFACED Roofing



JAP-A-TOP SLATE SURFACED ROLL ROOFING
 Jap-a-Top Slate Surfaced Roll Roofing is made of long fibre felt saturated with pure asphalt. Into this is imbedded a heavy layer of **Genuine Crushed Slate** of either natural dark red or sea green color. The result is a durable, fine appearing roofing that we **guarantee for 15 years.**

Fire Resisting

The non-inflammable materials in the base covered with slate give maximum fire resistance. Sparks from a chimney may set fire to a wood shingled building at any time. With Jap-a-Top Slate Surfaced Roofing on your house you are protected from this danger. Meets fire underwriters requirements everywhere. Ideal for farm use.

Easy to Apply

Comes in rolls of 108 square feet per roll. We furnish large headed galvanized roofing nails and sufficient cement for seams which must overlap to make it waterproof. Each roll covers 100 square feet. Much easier than shingles to apply. Weight full 85 pounds to the roll.

Colors Permanent

You will find this roofing is a non-conductor of heat and cold, which means a fuel saving in winter and a cooler house in summer. The colors are permanent—will not fade—not affected by sun or rain. This roofing **contains no coal tar.** Samples sent free on request, but you are perfectly safe in buying direct from this page, as we will return your money and freight both ways if you are not thoroughly satisfied.

Note: All Jap-a-Top Roofings Carry Underwriters Label

SA2059—Dark Red Weight per roll 85 pounds SA2065—Sea Green
 Price, per roll of 108 square feet. **\$1.95**
 Shipped from Davenport, Chicago, Cincinnati, Kansas City or Factory in New York

Gordon-Van Tine Co. Catalogue – c.1924

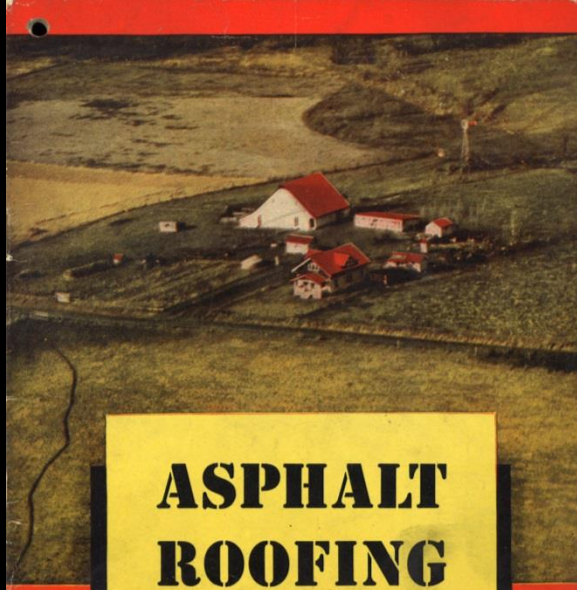

ASPHALT ROOFING ON THE FARM

A Practical Handbook on How to Meet Wartime Housing Problems
on the Farm with Serviceable ASPHALT Roofing Products

Asphalt Roofing on the Farm— c.1950



Barn Framing / Truss System

- Log
- Heavy Timber Frame
- Pole Construction
- Plank Truss Frame
 - Braced Truss
 - Iowa Truss
 - Shawver Truss
- Concrete
- Clay Tile / Brick

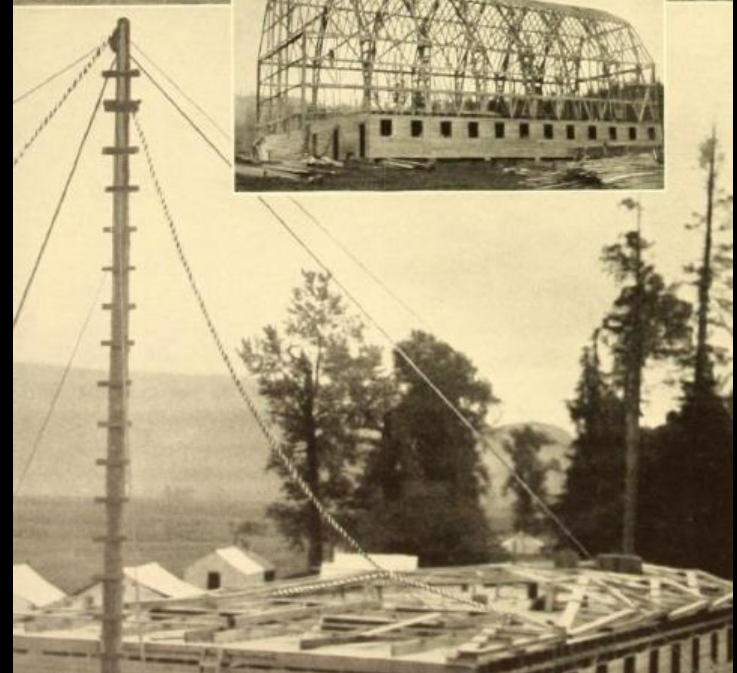
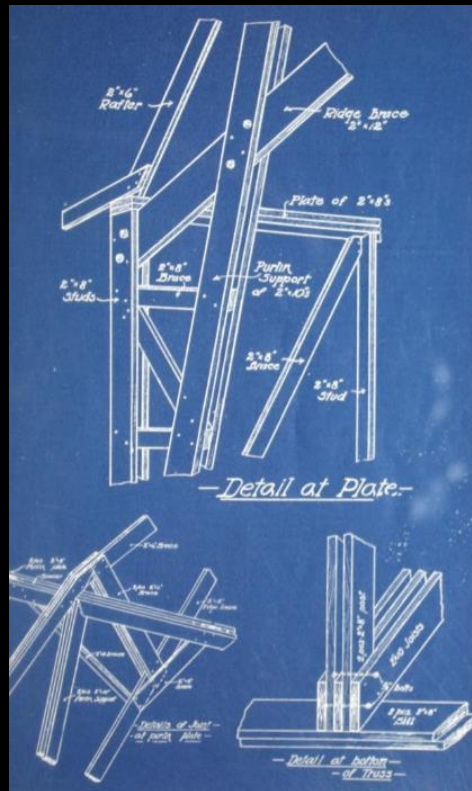
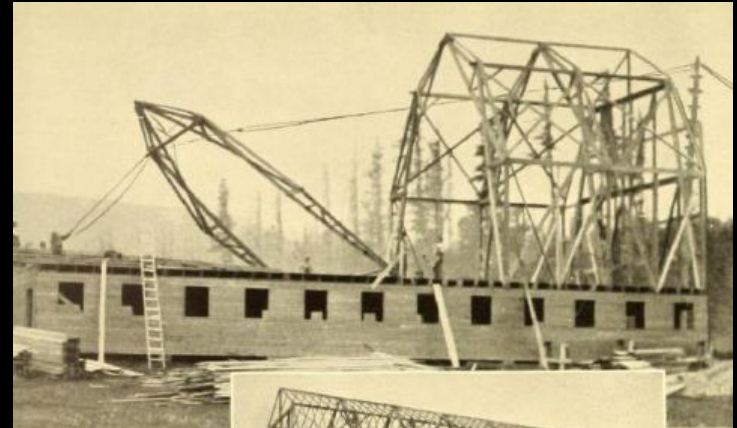

Barn Framing / Truss System

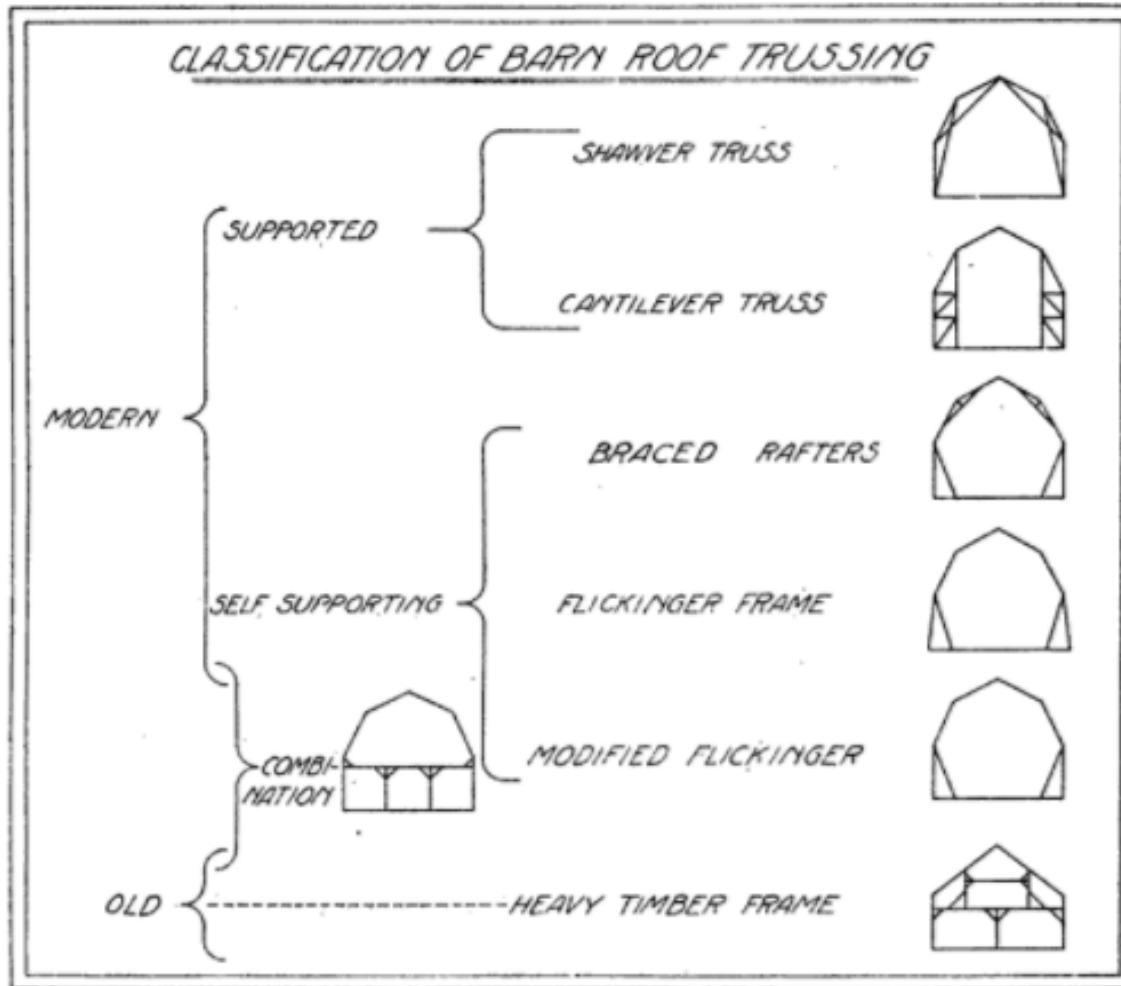

Fig. 1. Six types of barn roof trusses



American Society of Agricultural Engineers

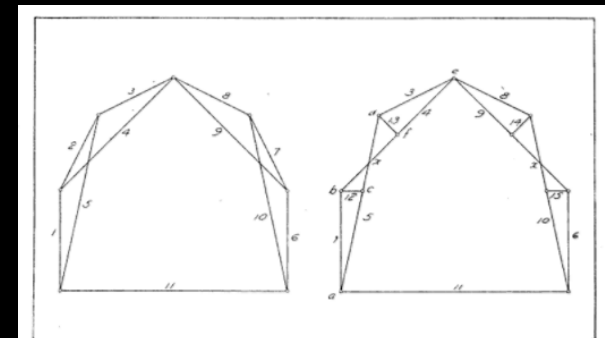
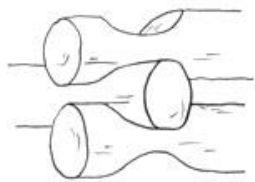

Fig. 2a

Fig. 2b

Two types of Shawver truss

Barn Log Framing



Saddle notch



Diamond notch

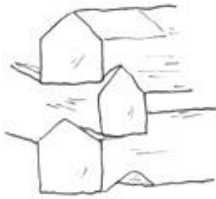

V-notch



Full Dovetail notch

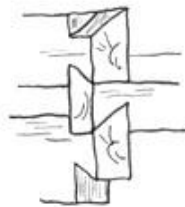

Half Dovetail notch



Square notch



Barn

Heavy Timber - Framing

Timber Framing Diagram

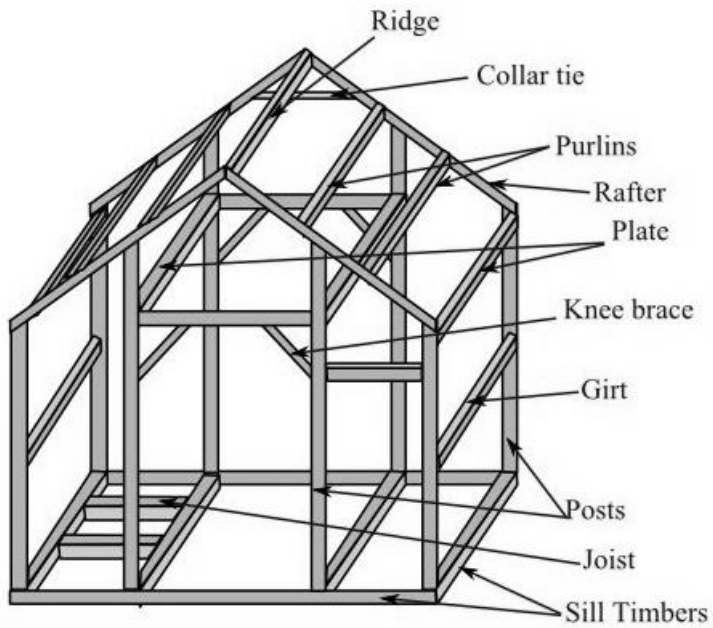

© 2011 MJ Logan



Barn

Pole Construction - Framing



Barn

Plank Framing - Gable Framing

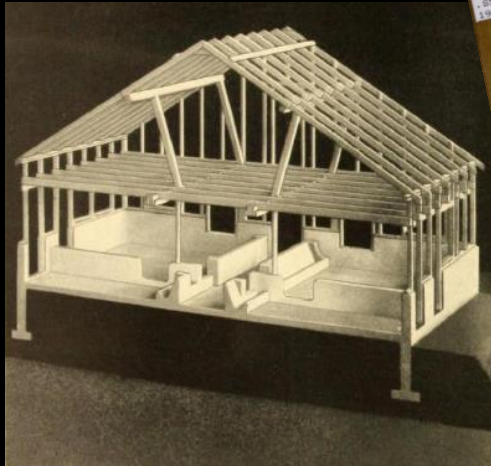

1904



Barn

Plank Framing – Gambrel Framing

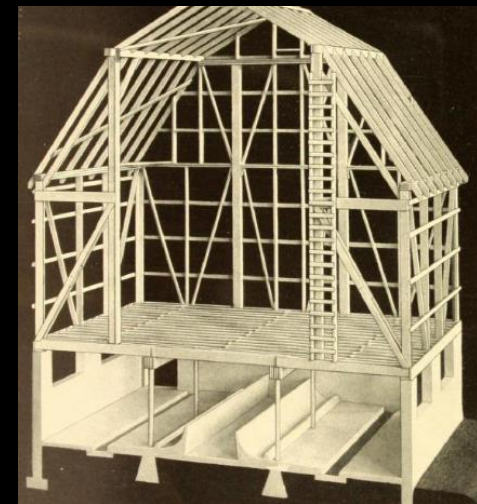
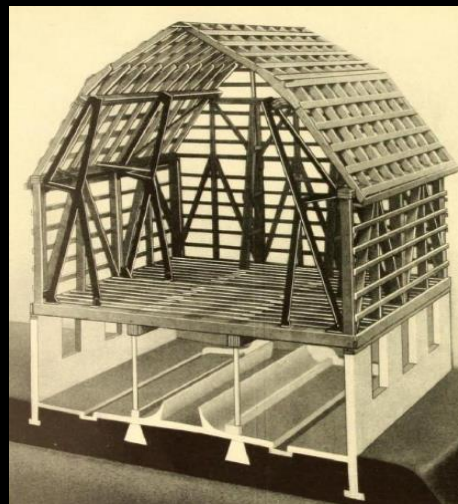

Barn

Plank Framing - Gambrel Framing

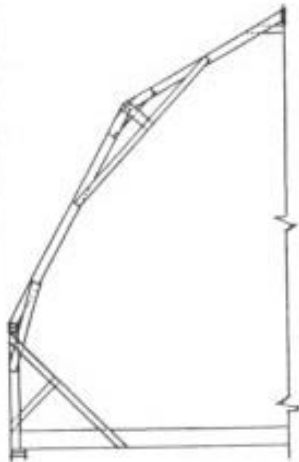

BRACED RAFTER

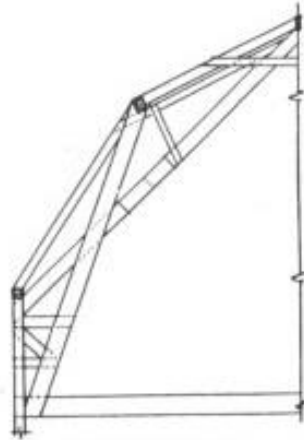

SHAWVER

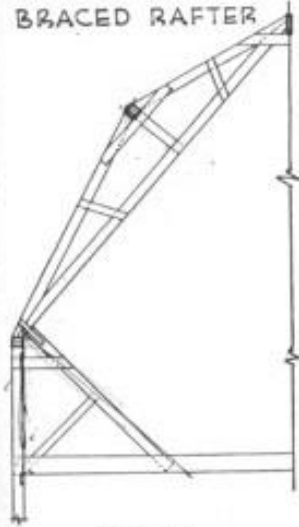

IOWA



STRAP



METAL ANCHOR



Barn

Braced Truss - Gambrel Framing

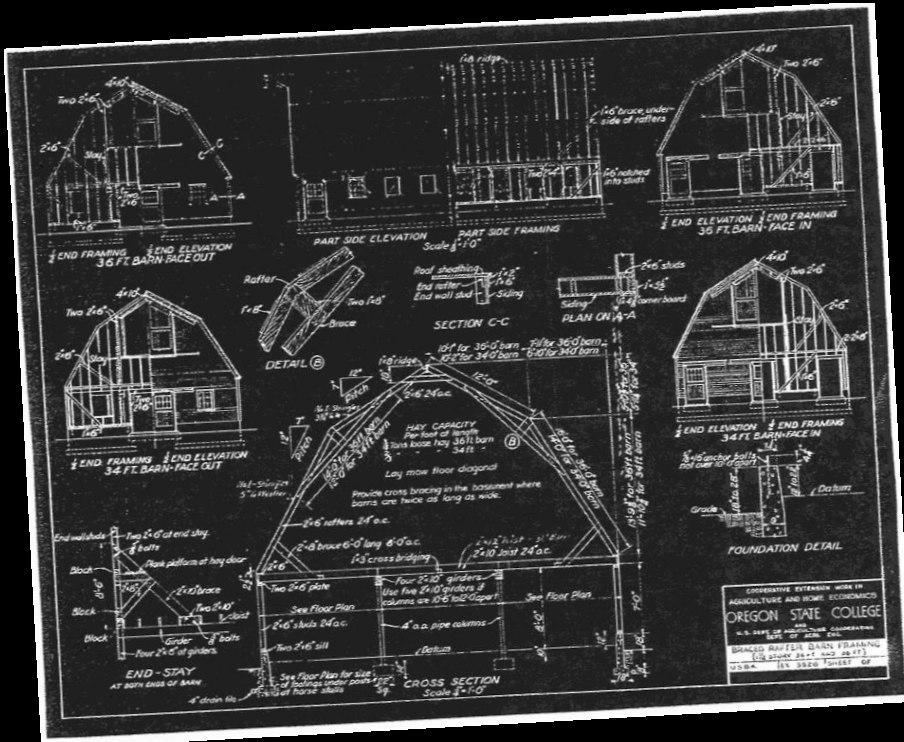

OSU Extension – Braced Truss

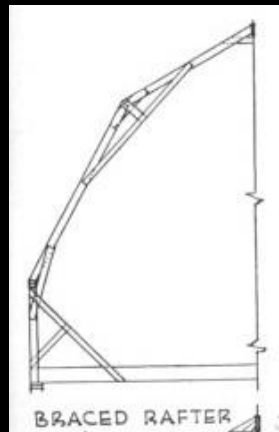
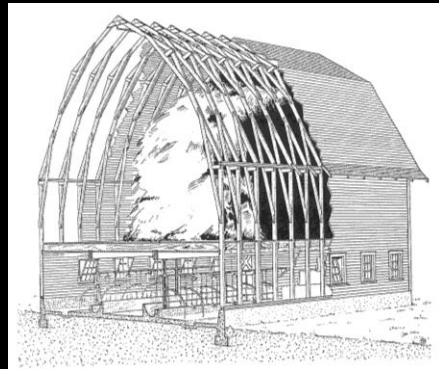

Barn

Iowa / Clyde Truss -Gambrel Framing



OSU Extension –
Iowa Truss

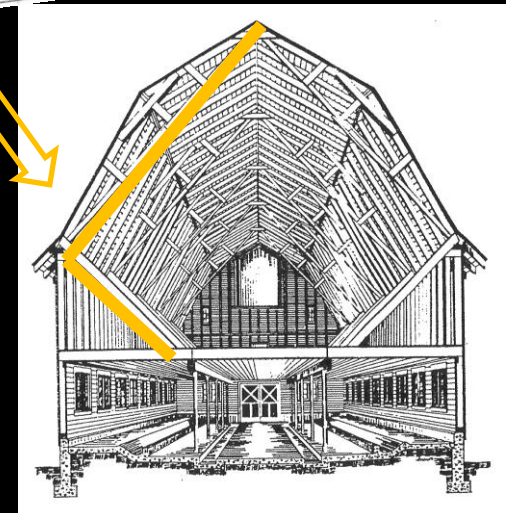
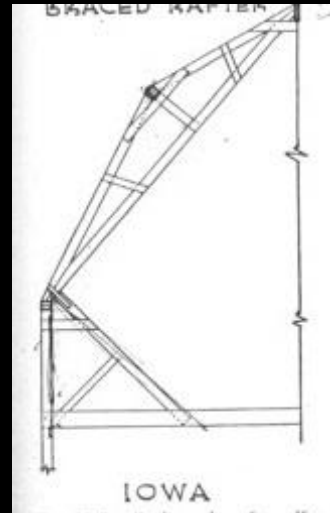
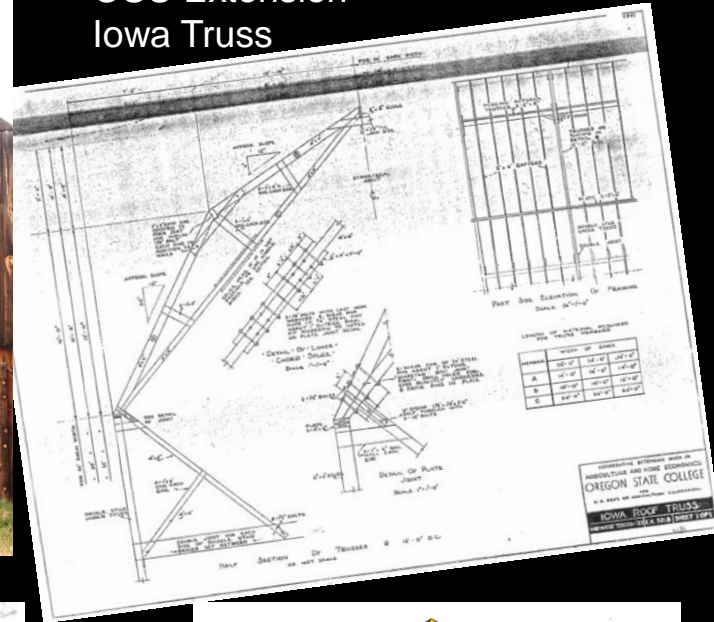

Truss developed around 1920

Barn

Shawver Truss - Gambrel Framing

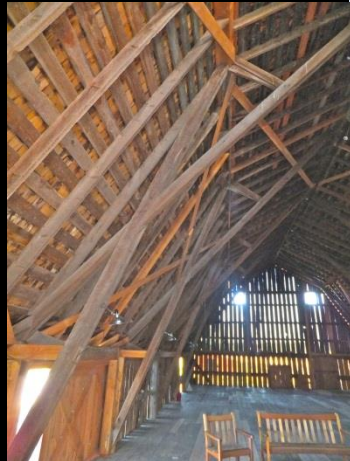
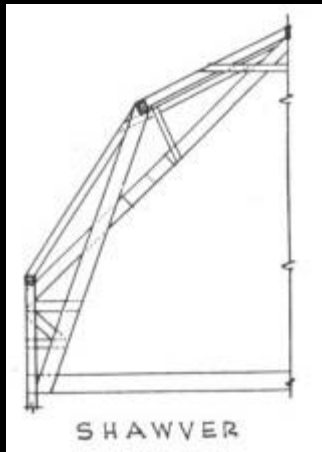
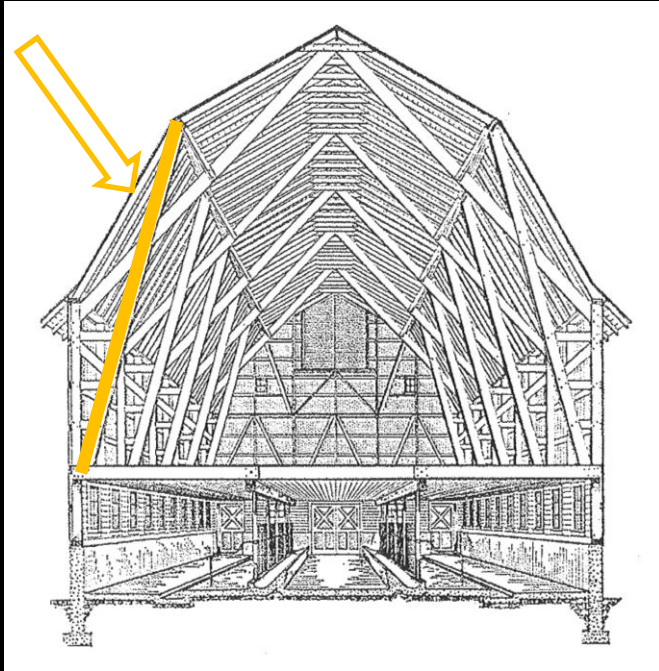

Truss developed late 19th Century

Barn

Plank Framing - Gothic Arch

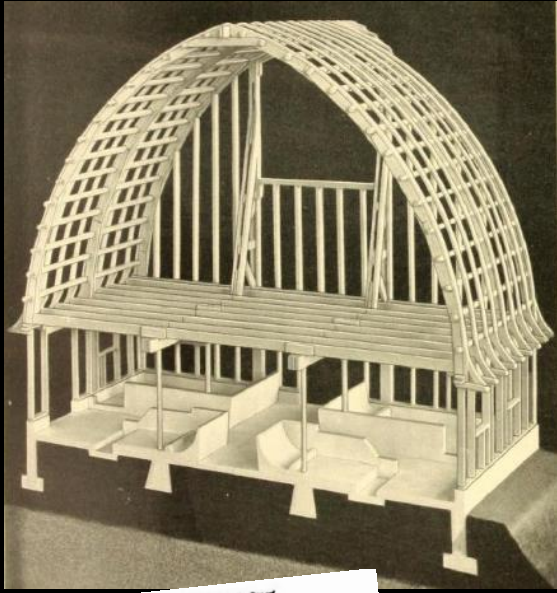

Bent

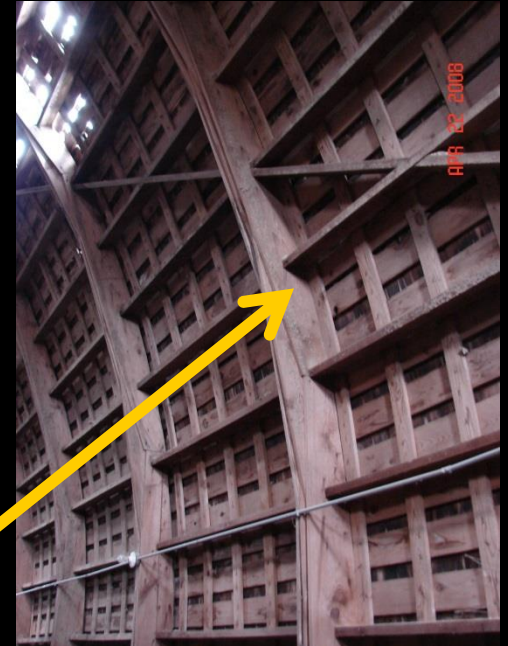

Plank

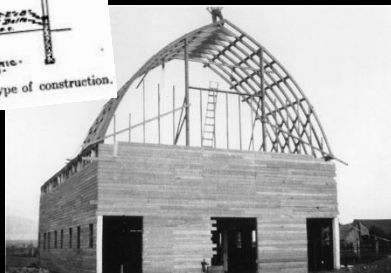
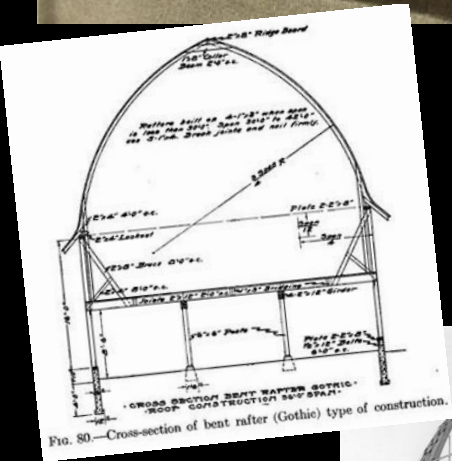

Truss



Barn

- Concrete - Poured & Block

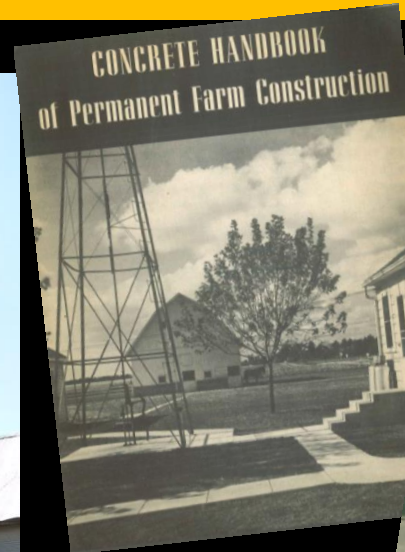

Portland Cement Association - 1946

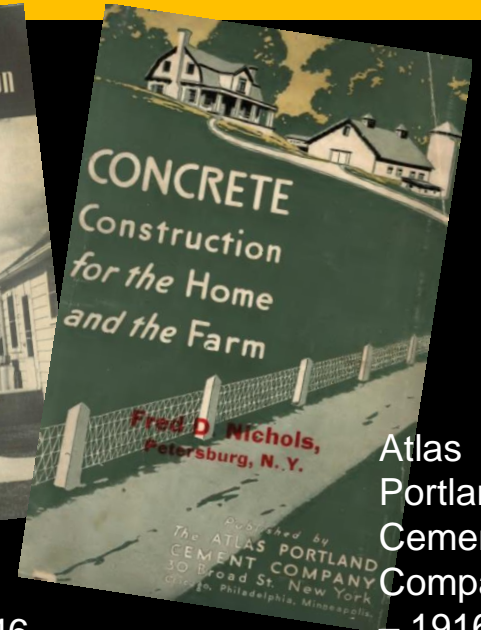

Atlas Portland Cement Company - 1916



Associated Farm Buildings

- Bunk Houses
- Fruit Dryers
- Granaries
- Hop Dryers
- Machine Shed
- Milk Houses
- Poultry Houses
- Root Cellars
- Silos
- Smoke Houses
- Water Towers



Associated Farm Buildings



Woodshed



Outhouse



Granary



Farmhouse



Homestead Cabin



Root Cellar

Silos - Typology

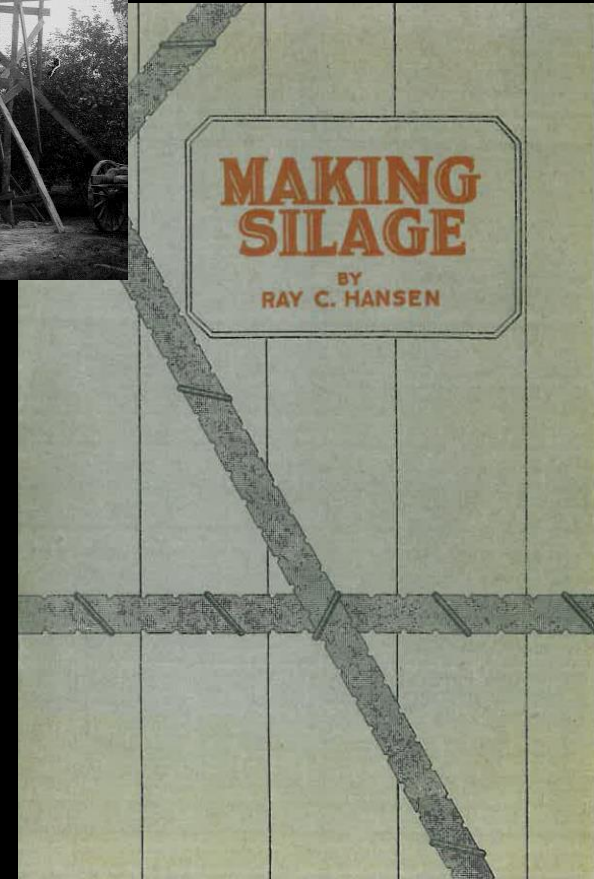
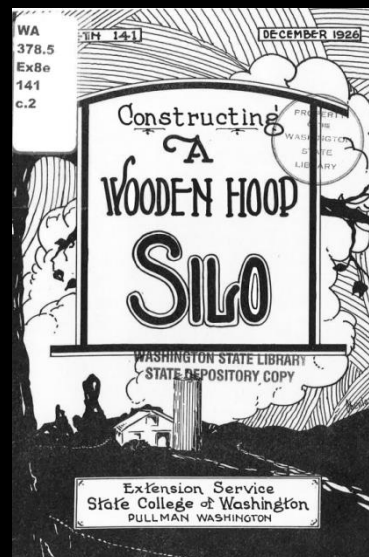
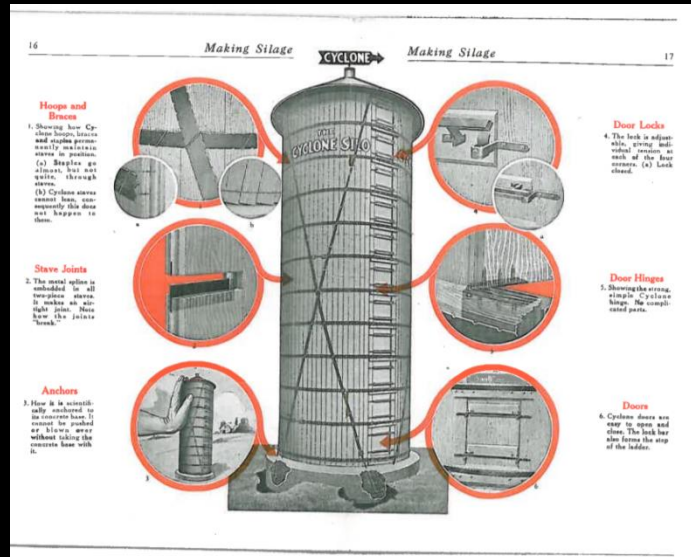

MAKING SILAGE
BY
RAY C. HANSEN

Silos - Typology



Wooden Octagonal Silo

Asotin Co – c.1895



Vertical Wood Stave Silo

Clark Co. – c.1900



King Silo

Klickitat Co. – 1920

Silos - Typology



Brick Silo
Spokane Co. – 1919



Concrete Stave Silo
Pierce Co. – c.1920



Glazed Tile Silo
Clark Co. - 1920

Silos - Typology



Steel Paneled Silo

Pierce Co. – c.1935



Poured Concrete Silo

Grays Harbor Co. – c.1935



Harvestore Silos

Adams County - c. 1948

Barn Hay Hoods



Fig. A—Carrier



Fig. B—Fork Open



Fig. C—Fork Closed

Hay Fork



Barn Hay Hoods



Garfield County, WA



Linn County, OR



Graham, WA



Benton County, OR



Klickitat County, WA

Keizer,
OR



Barn Ventilation



A ventilating system must be planned individually for the building into which it is to go.

Barn Ventilation

By L. KLIMA,
Barn Ventilation Expert

IN THE days of straw sheds when stock was not properly housed, very little attention was paid to pure air, and not much was known about its real food and life-giving value. It soon became apparent to those making a study of stock raising that these animals would be more productive when housed in warm buildings, and this is what has brought about the modern barn. It is true that

the warm room has increased the product, for example, the flow of milk from the dairy cow; but this warm, tight building has also brought about a condition that breeds disease; and the disease is proving to be a menace to live stock and mankind.

It has been proved that pure air is two-thirds of a cow's ration; in other words, for every pound of feed and water

combined that is consumed it requires the oxygen from two pounds of pure air to properly assimilate this feed. It is true that no farm stock buildings are air tight; but if the stock can get only one-half the required amount of pure air, it would have the same effect as if they were given only a part of the feed and water they naturally require to sustain life and make them productive.

Much has been written on the subject of ventilation for farm



Winn Barn,
Weston, OR
1916



The King System, which is the best part of the King Ventilating System, used in the past but is now almost obsolete. It is a simple, but not a scientific system, and great care should be used in selecting it. The King System ventilator, as illustrated above in the past, was made of thin wall sheet metal, and was not a true ventilator, but a mere hood for the roof. It is in the past part of a ventilating system, and great care should be used in selecting it. The King System ventilator, as illustrated above in the past, was made of thin wall sheet metal, and was not a true ventilator, but a mere hood for the roof. It is in the past part of a ventilating system, and great care should be used in selecting it.

Winn
General Manager
King Ventilating System

MAJESTIC VENTILATORS

For Barns and Stables

Majestic Ventilators are scientifically and constructed. They have been for the best and most approved models.

Each ventilator required is governed by the number of cattle in the building. If more than twenty cattle under one roof I have two or more ventilators of the King System.

Each ventilator has a continuous draft which draws out the foul air and replaces it with fresh air, without causing a draft.

Each of these ventilators will go a long way in making any outbuilding attractive. The service consists in keeping the building ventilated under all weather conditions. Incidentally necessary in order to get the best from stock of any kind. Animals better in a building continually supplied with fresh air. Considering the low price and the high quality of our ventilators, no farmer can afford to be without one.

Extra heavy 22, 24 and 26-gauge galvanized steel is used in the manufacture of our Majestic Ventilators, according to size. Nothing thinner than 26-gauge galvanized steel is permitted. This is much thicker stock than is generally used. Each ventilator is equipped with four stay rods which hold it securely in place on the roof. A wire screen is provided to keep the birds out. When properly secured to the roof, our ventilators, owing to their weight and scientific attachment, will resist unusually severe storms.

Price Ventilators for Small Buildings.

Price Ventilators for Large Buildings.

Capacity	Height	Weight	Price
10	10	10	10.00
15	15	15	15.00
20	20	20	20.00
25	25	25	25.00
30	30	30	30.00
35	35	35	35.00
40	40	40	40.00
45	45	45	45.00
50	50	50	50.00
55	55	55	55.00
60	60	60	60.00
65	65	65	65.00
70	70	70	70.00
75	75	75	75.00
80	80	80	80.00
85	85	85	85.00
90	90	90	90.00
95	95	95	95.00
100	100	100	100.00

Price of Prince Ventilators for Small Buildings.

Capacity	Height	Weight	Price
10	10	10	10.00
15	15	15	15.00
20	20	20	20.00
25	25	25	25.00
30	30	30	30.00
35	35	35	35.00
40	40	40	40.00
45	45	45	45.00
50	50	50	50.00
55	55	55	55.00
60	60	60	60.00
65	65	65	65.00
70	70	70	70.00
75	75	75	75.00
80	80	80	80.00
85	85	85	85.00
90	90	90	90.00
95	95	95	95.00
100	100	100	100.00

SEARS, ROEBUCK AND CO., CHICAGO, ILLINOIS.

Barn

Cupolas & Ventilators



Whitman Co. - The Smith
Place - 1935



Snohomish Co. - Grimm-
Jensen Farm - 1932



Adams Co. - Krause Barn -
1901



Pierce Co. - c1923



Spokane Co. -
Hyslop Farm - 1926



Pend Oreille Co. -
LaPorte Barn - 1901

Barn Equipment



Cook Family Farm – 1927



Shady Nook Farm – 1920



Smith Place – 1935



Grimm-Jensen Farm – 1932



Schindler – 1909



Barn Decoration



Heath Farm – c.1920



Bolick Farm – 1895



Ebby Road Farm – 1923



Brown Farm, Olympia – c. 1905

Heritage Barn Nominations Decoration



Cochran-Rice Farm, Cottage Grove



Barn, Oakland, OR



Polson Farm, Waterville, WA – c. 1915



Gribble Barn, Canby, OR

The Washington State

Department of Archaeology & Historic Preservation



Michael Houser, *WA State Architectural Historian*
360.586.3076 or michael.houser@dahp.wa.gov

